

Korn- und Tupferzangen – Sponge- and Dressing Forceps

Sehnenfazzangen

Tendon Seizing Forceps

BF



HERZ

BF303R

Sehnenfazzange

Tendon seizing forceps

155 mm, 6"



JACKSON

BF306R

Sehnenfazzange

4 x 5 Zähne

Tendon seizing forceps

4 x 5 teeth

150 mm, 6"

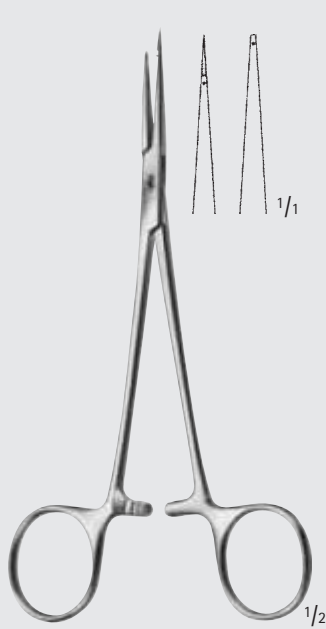

FO950R

Sehneneinflechtkelemme

Tendon interlacing forceps

150 mm, 6"

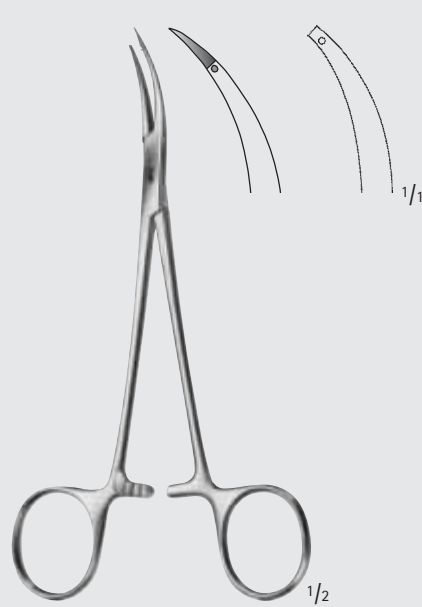

FO951R

Sehneneinflechtkelemme

Tendon interlacing forceps

150 mm, 6"

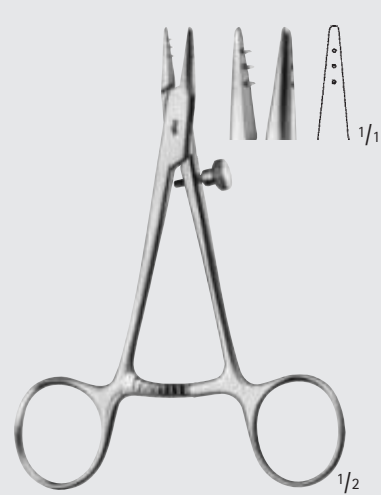

BF307R

Sehnenfazzange

Tendon seizing forceps

120 mm, 4 3/4"



Korn- und Tupferzangen – Sponge- and Dressing Forceps Sehnenfasszangen Tendon Seizing Forceps

BF

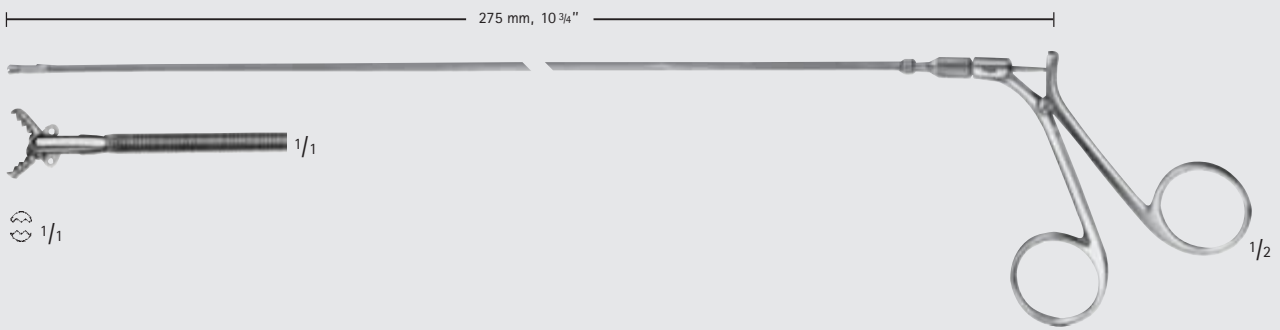

JÄGER

BF325R

Sehnen- und Kreuzband-
Durchziehzange
flexibler Schaft

Tendon- and cross ligament
passing forceps
flexible shaft



BF315R	BF316R	BF324R	BF326R
gebogen curved	gebogen curved	gerade straight	gerade straight
150 mm	185 mm	150 mm	185 mm
6"	7 1/4"	6"	7 1/4"

BRAND

BF315R-BF326R

Sehnenführungs-
zangen
Tendon holding forceps



KLEINERT-KUTZ

BF320R

Sehnen-
durchzieh-
zange
Tendon passing forceps
205 mm, 8"



MILLIMETERS

Knochenhaltezangen, Hohlmeißelzangen – Bone Holding Forceps, Bone Rongeurs

Sehnenstripper

Tendon Strippers

FO



1/1

1/2

Ø
diam.

FO923R 3 mm

Sehnenstripper
Schaftlänge: 190 mm
Tendon stripper
Shaft length: 7 1/2"
300 mm, 11 1/2"

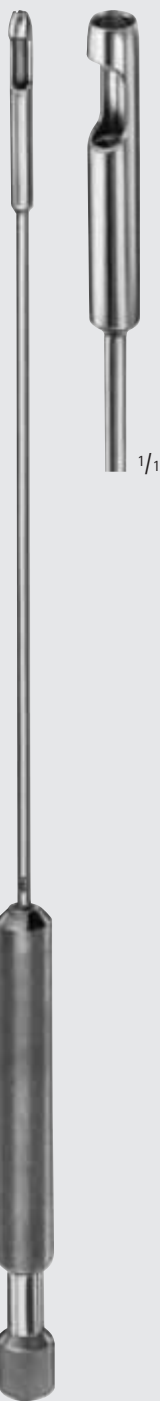

1/1

Ø
diam.

FO925R 5 mm

Sehnenstripper
Schaftlänge: 390 mm
Tendon stripper
Shaft length: 15 1/3"
495 mm, 19 1/2"

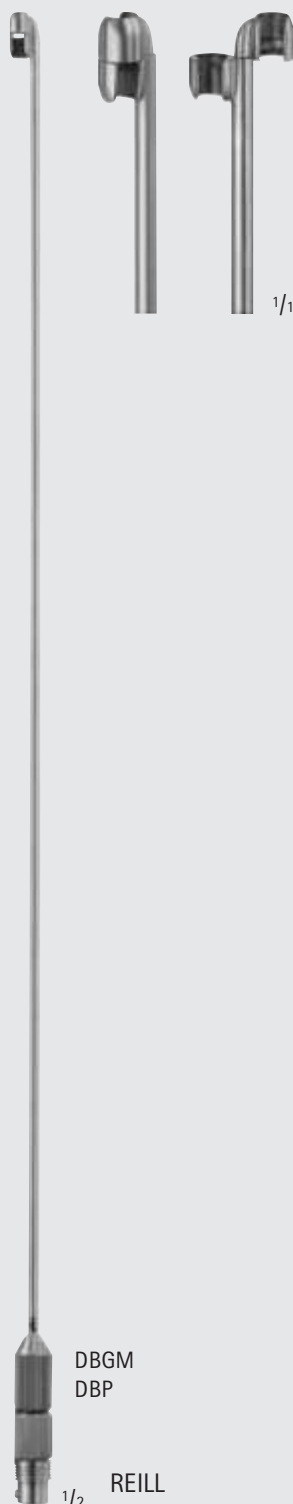

1/1

DBGM
DBP

REILL

1/2

Ø
diam.

FO928R 4 mm

FO930R 6 mm

Sehnenstripper
Schaftlänge: 350 mm
Tendon stripper
Shaft length: 13 3/4"
395 mm, 15 1/2"

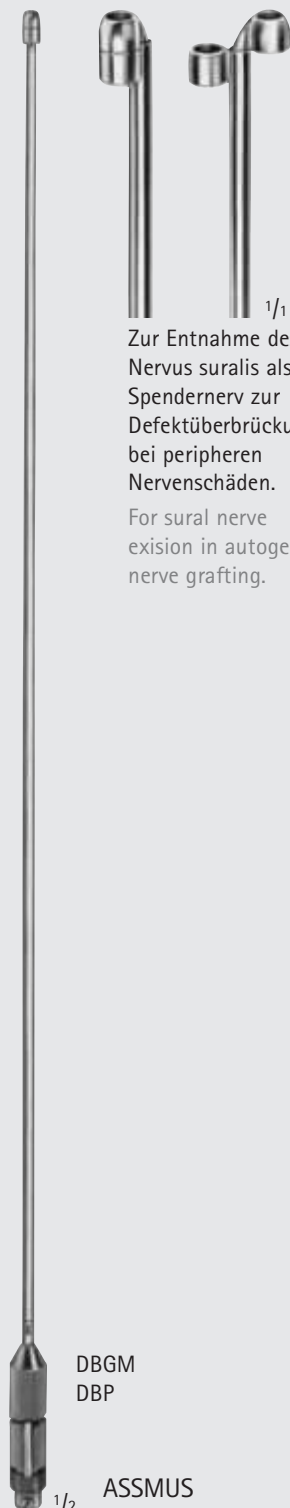

1/1

DBGM
DBP

ASSMUS

1/2

Ø
diam.

FD610R 3 mm

Nervenstripper, stumpf
Schaftlänge: 350 mm
Nerve stripper, blunt
Shaft length: 13 3/4"
395 mm, 15 1/2"

Zur Entnahme des
Nervus suralis als
Spendernerve zur
Defektüberbrückung
bei peripheren
Nervenschäden.

For sural nerve
exision in autogenous
nerve grafting.



Knochenhaltezangen, Hohlmeißelzangen – Bone Holding Forceps, Bone Rongeurs

Sehnenstripper
Tendon Strippers



FO931R FO932R FO933R FO934R ^{1/1}



BRUNNELL

\emptyset
diam.

FO931R	2 mm
FO932R	3 mm
FO933R	4 mm
FO934R	6 mm

135 mm, 5 1/4"

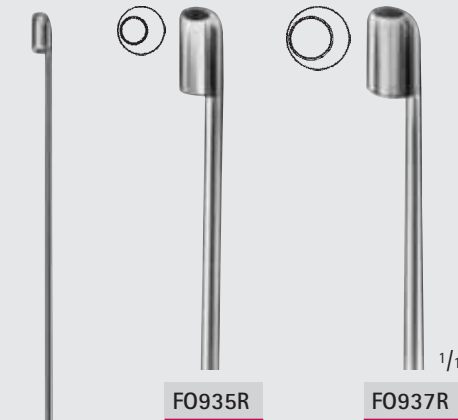

FO935R

FO937R ^{1/1}



^{1/2}

\emptyset
diam.

FO935R	3 mm
FO937R	5 mm

300 mm, 12"



^{1/1}

\emptyset
diam.

FO939R	5 mm
--------	------

500 mm, 19 1/2"

FO

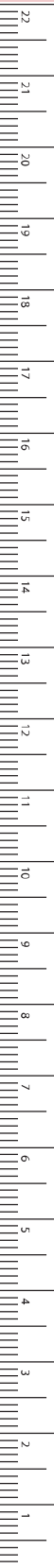

MILLIMETERS

Knochenhaltezangen, Hohlmeißelzangen – Bone Holding Forceps, Bone Rongeurs
 Sehnedurchziehsonden
 Tendon Passing Probes

FO

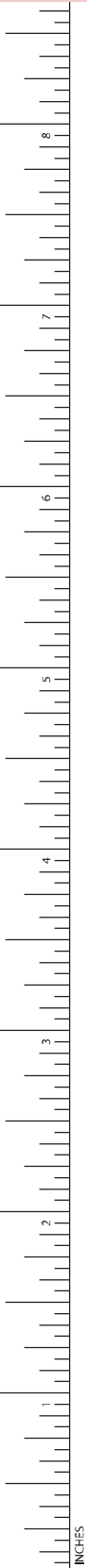

$\frac{1}{2}$
BUNNELL
FO940R
 230 mm, 9"

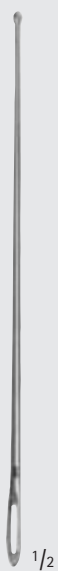

$\frac{1}{2}$ Knopf-Ø
 diam. of tip
BN034R 2,5 mm
 145 mm, 5 $\frac{3}{4}$ "



$\frac{1}{2}$ Knopf-Ø
 diam. of tip
BN036R 2,5 mm
 160 mm, 6 $\frac{1}{4}$ "



$\frac{1}{2}$ Knopf-Ø
 diam. of tip
BN040R 3,0 mm
 200 mm, 8"